

ATEKO a.s.

1949 – 2019

Heat Exchangers

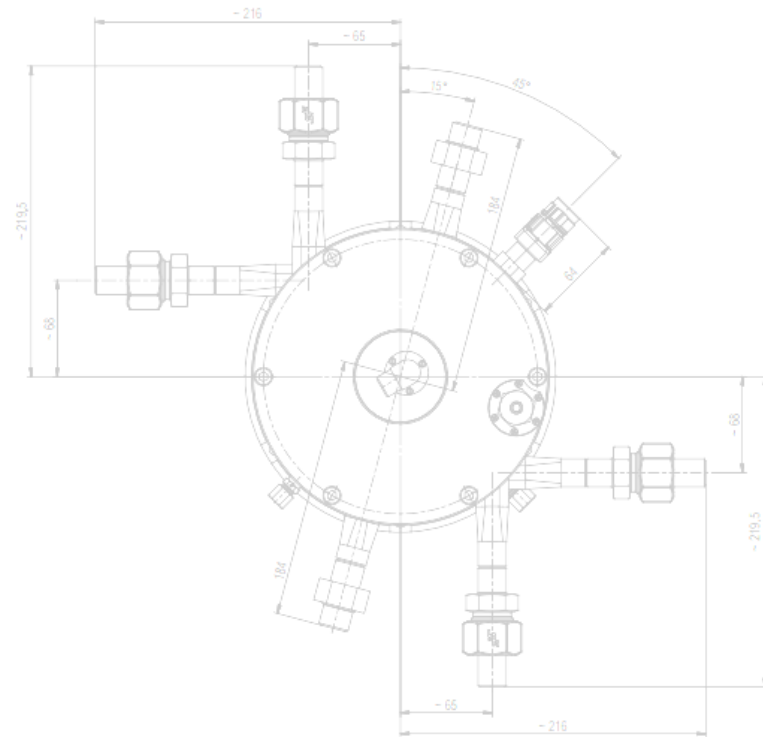
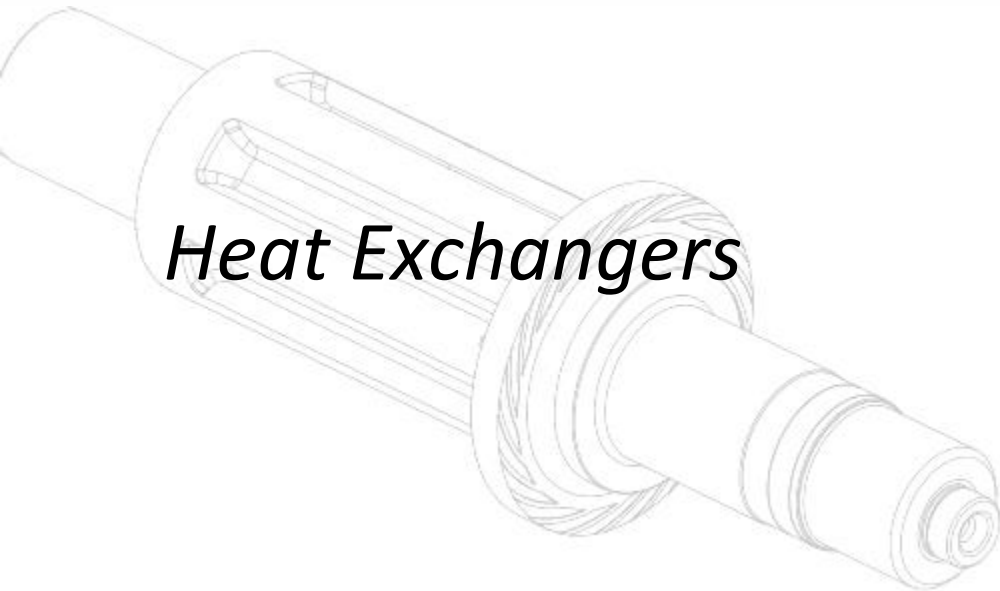

Shell – Tube Heat Exchangers

- » 2018 – Wound Exchanger, customer in Russia via Germany
- Total heat area of heat exchanger is approx. 42,6 m².
- Design pressure (for all spaces) 5 MPa,g
- Working medium - mixture of: Hydrogen, Ethane, Ethylene, Propane, Propylene, Nitrogen
- ASME Sect. VIII, Div.1 without U-stamp, EAC (TR TS 032/2013, TR TS 010/201)Z

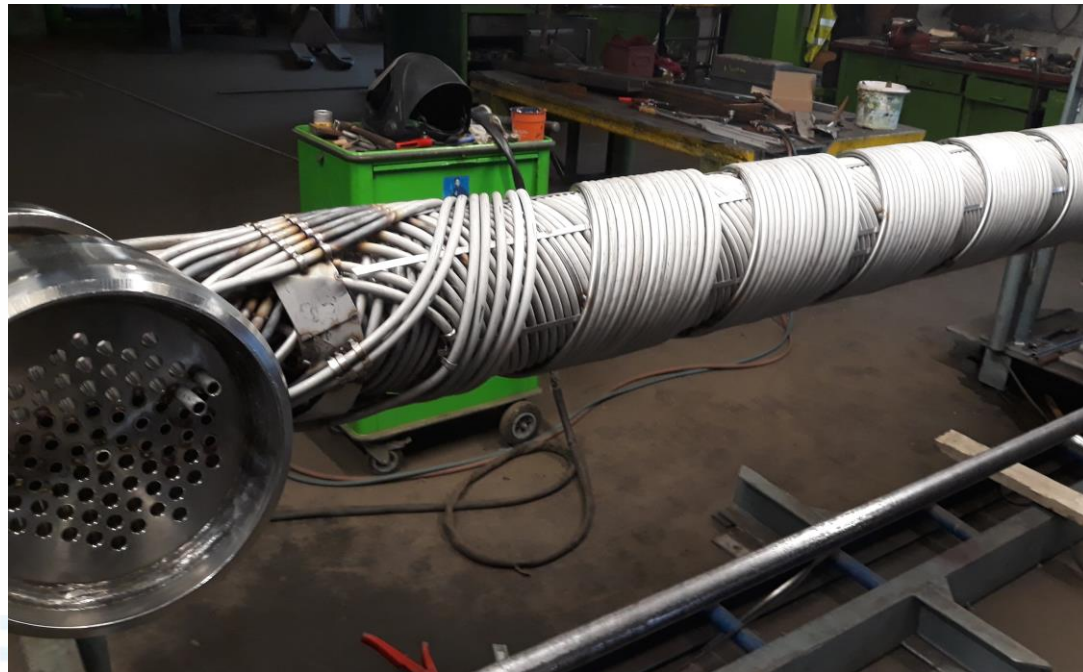

Shell – Tube Heat Exchangers

» 2016 – Secondary Helium Cooler, S-Allegro Project, CZ



Shell – Tube Heat Exchangers

» 2016 – Oil Coolers, Nizhnekamsk, Russia



Shell – Tube Heat Exchangers

» 2016 – Oil Coolers for RWE – UGS Dolní Dunajovice, CZ



Shell – Tube Heat Exchangers

» 2015 – Oil Coolers, 8 sets, Nizhnekamsk, Russia



Shell – Tube Heat Exchangers

» 2015 – Hydrocarbon Gas Coolers, 12 sets, Nizhnekamsk, Russia

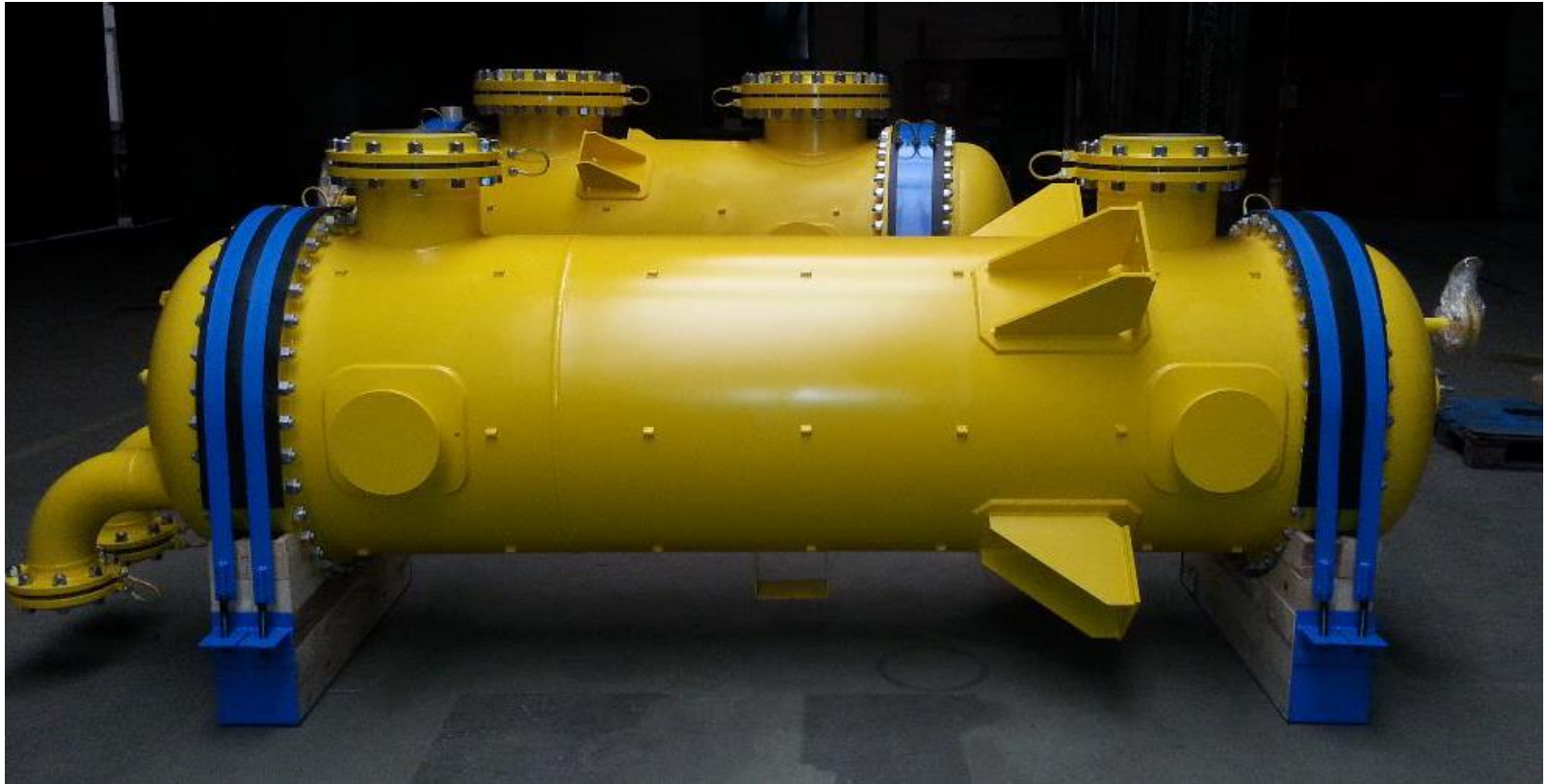

Shell – Tube Heat Exchangers

» 2015 – KUP Sealing Steam Condenser, Goole, UK



Shell – Tube Heat Exchangers

- » 2015 – KUP Sealing Steam Condenser, Blower and valves included, Sokolov, CZ



Shell – Tube Heat Exchangers

- » 2015 – Low temperature spiral wound exchanger, hydrogen and hydrocarbons, ASME VIII Div. 1, Lukoil Stavrolen cold box, Russia



Shell – Tube Heat Exchangers

» 2015 – Heat exchangers, 10 sets, Germany



Shell – Tube Heat Exchangers

» 2015 – Bypass Butane Cooler, Kuybyshev, Russia



Shell – Tube Heat Exchangers

» 2014 – Oil Coolers, 4 pieces, Salavat, Russia



Shell – Tube Heat Exchangers

- » 2014 – Propane Oil Coolers, accessories included, Belarusneft, Belarus



Shell – Tube Heat Exchangers

» 2014 – Nitrogen Aftercooler, Cryogas, Russia



Shell – Tube Heat Exchangers

- » 2013 – Skid Hydrogen Gas (Cooler, Separator, Valves, Piping), Tarnow, PL



Shell – Tube Heat Exchangers

» 2013 – Hydrogen Gas Cooler, Ryazan, Russia



Shell – Tube Heat Exchangers

» 2013 – Oil Cooler, Kirishi, Russia



Shell – Tube Heat Exchangers

» 2012 – Intercooler, Nizhnekamsk, Russia



Shell – Tube Heat Exchangers

» 2011 – Flue Gas Cooler, Lány, CZ

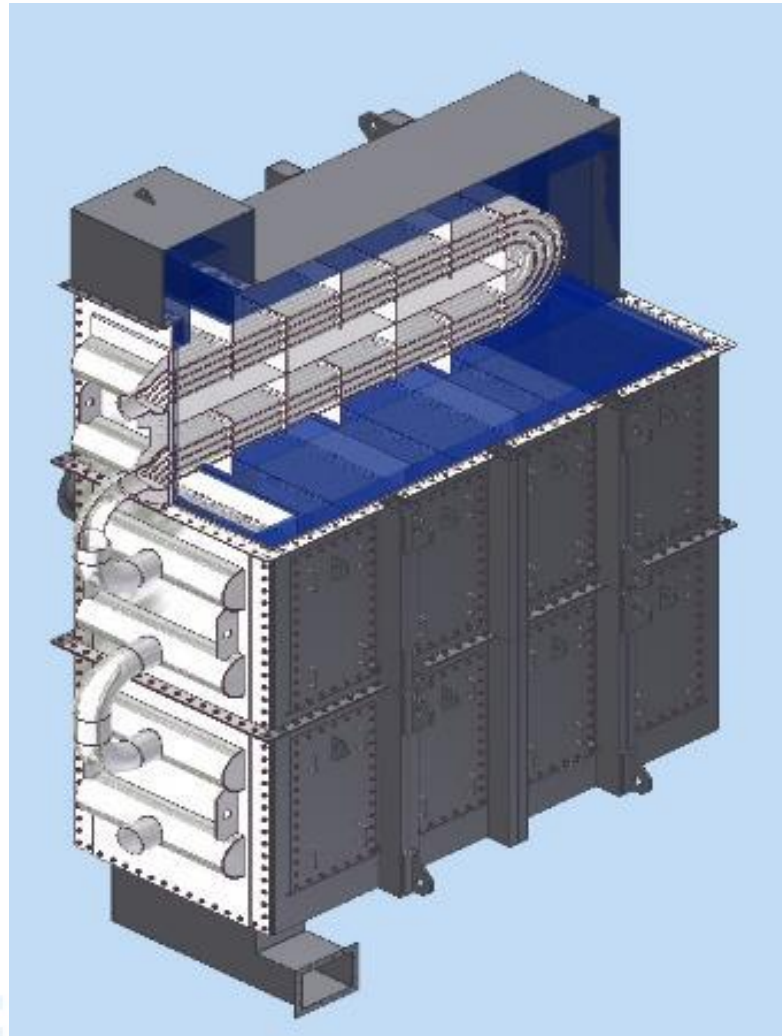

Shell – Tube Heat Exchangers

- » 2002 and 2011 – Heat Exchangers for H₂SO₄ Unit, Neratovice, CZ

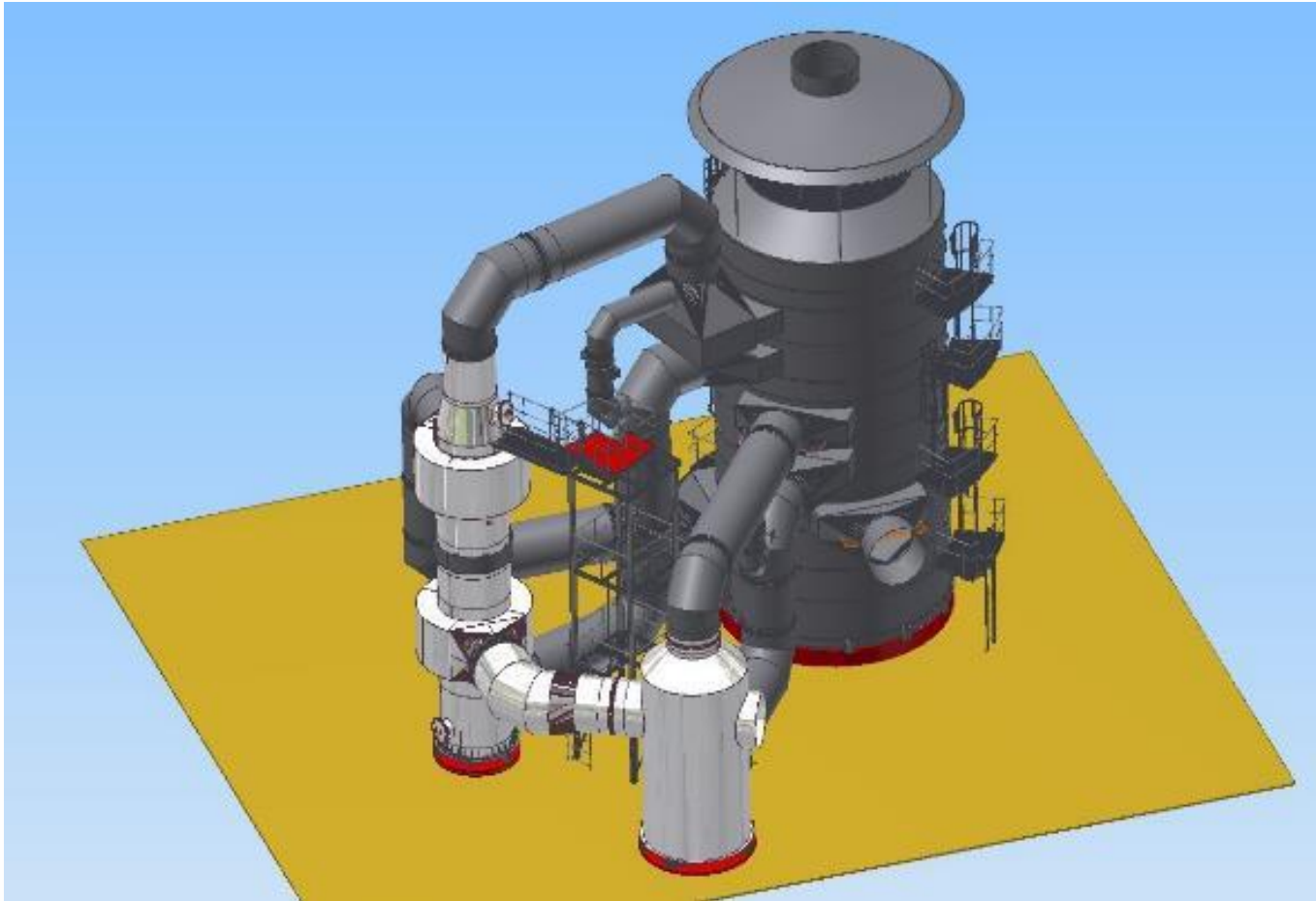

Shell – Tube Heat Exchangers

» 2010 – Gas Electric Heater, Naryan Mar, Russia



Shell – Tube Heat Exchangers

- » 2009 – Skid – A Water Cooling Unit for Hydrogen Compressor, Kstovo, Russia

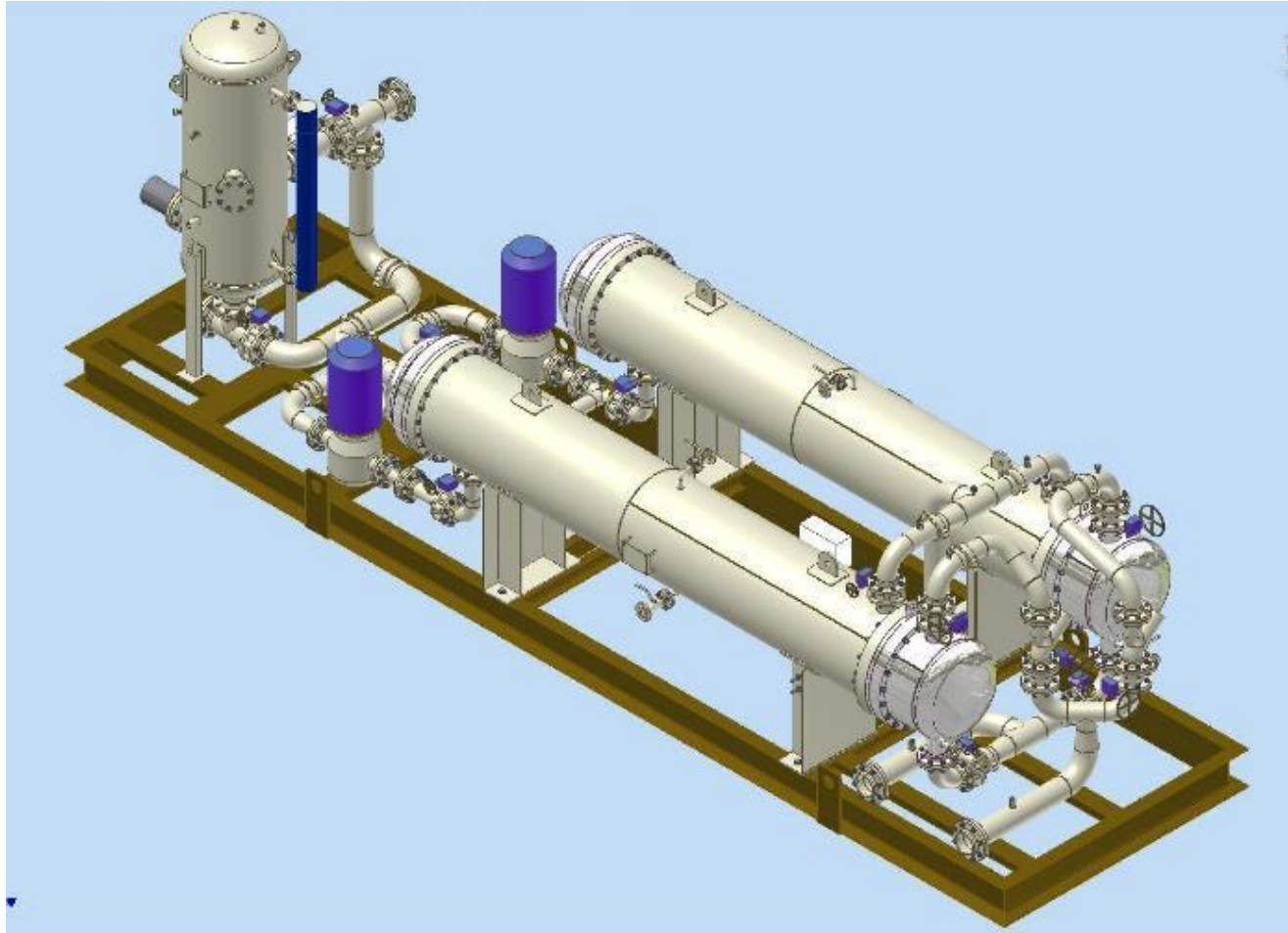

Thank you for your attention

<http://www.ateko.cz>

ateko@ateko.cz

